

APPLITEC

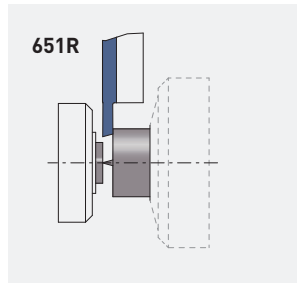

INFO	Codification Bezeichnungsschlüssel Designation key	Paramètres de coupe indicatifs Empfohlene Schnittwerte Standard machining data	Nuances Sorten Grades > <b>3.02</b>
<p><b>SERIES 630 / 640</b></p> <p>Tournage et gorge</p> <p>Drehen und Einstechen</p> <p>Turning and grooving</p>	Porte-outils Halter Holders	 <b>630 / 640</b>	> <b>3.06</b>
	Tournage avant Vorwärts drehen Front turning	<b>632 / 642</b>	 > <b>3.08</b>
	Tournage arrière Rückwärts drehen Back turning	<b>633 / 643</b>	 > <b>3.11</b>
	Fonçage-tournage Einstechen und drehen Grooving and turning	<b>634 / 644</b>	 > <b>3.19</b>
	Chanfreinage Anfasen Chamfering	<b>635 / 645</b>	 > <b>3.24</b>
	Filetage Gewinde drehen Threading	<b>636 / 646</b>	 > <b>3.26</b>
	Plaquettes à rayon Radius Wendepplatten Radius inserts	<b>637 / 647</b>	 > <b>3.28</b>
	Plaquettes ébauches WSP-Rohlinge Blank inserts	<b>631-EP / 641-EP</b>	 > <b>3.30</b>
	<p><b>SERIES 650 / 660</b></p> <p>Tronçonnage</p> <p>Abstechen</p> <p>Parting off</p>	Porte-outils Halter Holders	 <b>650 / 660</b>
Tronçonnage Abstechen Parting off		<b>651 / 661</b>	 > <b>3.34</b>
Tronçonnage - coupe déportée Abstechen - versetztes Schneiden Parting off - cut off line		<b>651R</b>	 > <b>3.39</b>
Plaquettes ébauches WSP-Rohlinge Blank inserts		<b>651-EP / 661-EP</b>	 > <b>3.44</b>
Pièces de rechange et accessoires Ersatzteile und Zubehör Spare parts and accessories			> <b>3.45</b>

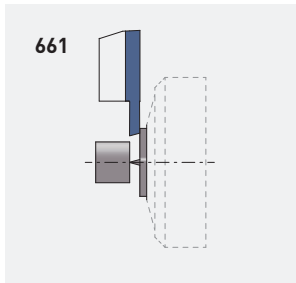
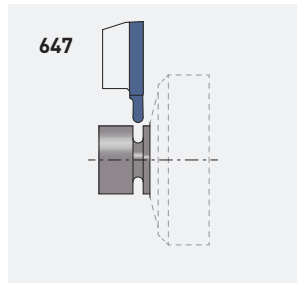
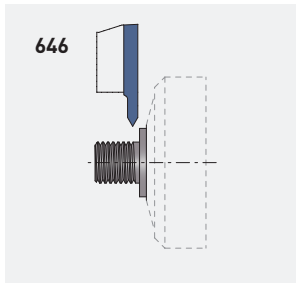
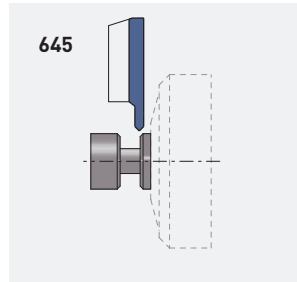
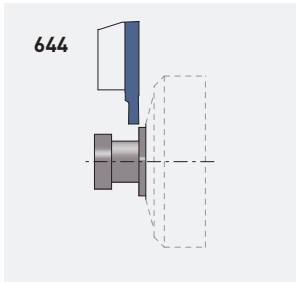
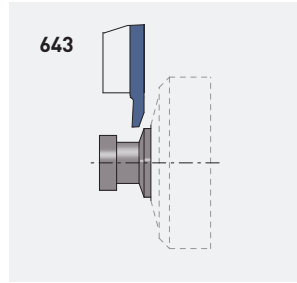
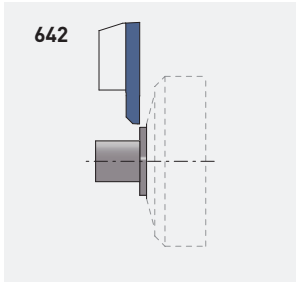

Codification des plaquettes PRO-Line série 600

WSP-Bezeichnungssystem für PRO-Line 600 Serie

Inserts designation key for PRO-Line 600 series

INFO



Dimension  
Abmessung  
Dimension

Rayon  
Radius  
Radius

Nuance  
Sorte  
Grade

Géométrie de coupe  
Schneidgeometrie  
Cutting geometry

brise-copeau  
Spanbrecher  
chip breaker

particularités  
Sondereigenschaften  
special features

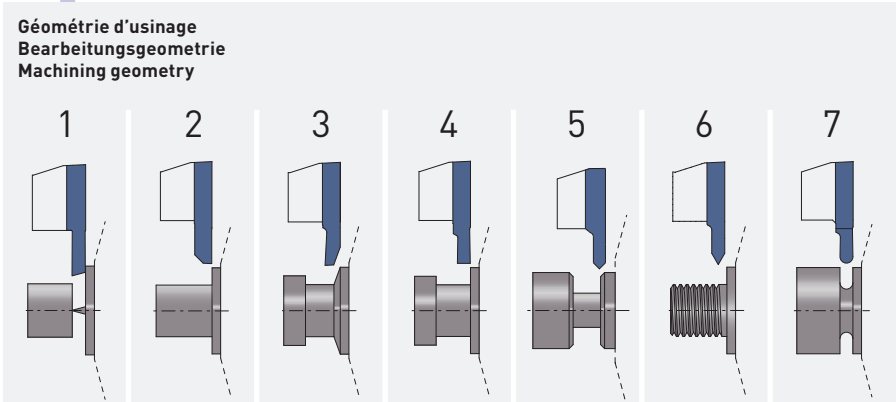

Gamme de produit  
Produktserie  
Product series

définit la compatibilité des plaquettes avec le porte-outil  
bestimmt die WSP und Halter Kompatibilität  
shows the inserts and holder compatibility

L = 3, 5 (chiffre impair / ungerade Zahl / uneven number)

R = 4, 6 (chiffre pair / gerade Zahl / even number)

**SERIES**

Tournage  
et gorge

Drehen und  
Einstechen  
Turning and  
grooving

W max = 3 mm  
L max = 8 mm

L R  
630 640

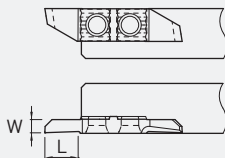

**SERIES**

Tronçonnage  
Abstechen  
Parting off

W max = 2.5 mm  
L max = 11 mm

L R  
650 660

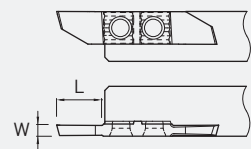

Applitec série 600  
Applitec 600 Serie  
Applitec 600 series

Système de serrage à denture avec 2 vis de fixation  
Spannsystem mit Verzahnung und 2 Schrauben  
Teeth clamping system with 2 screws

## Paramètres de coupe indicatifs

## Empfohlene Schnittwerte

## Standard machining data

Matière Werkstoff Material	Tournage Drehen Turning			Tronçonnage Abstechen Parting off		
	VC	630/640		VC	650/660	
		Prof. de passe Schnitttiefe Depth of cut	Avance Vorschub Feed		Largeur de coupe Abstechbreite Cutting width	Avance Vorschub Feed
(m/min)	(mm)	(mm/U)	(m/min)	(mm)	(mm/U)	
Acier de décolletage Automatenstahl Free-cutting steel	<b>P</b> 120 - 200	0.05 - 1.0 1.0 - 4.0	0.01 - 0.15 0.05 - 0.25	80 - 150	0.50 - 1.50 1.50 - 2.50	0.01 - 0.08 0.03 - 0.15
Acier Stahl < 600 N/mm <sup>2</sup> Steel	<b>P</b> 80 - 160	0.05 - 1.0 1.0 - 4.0	0.01 - 0.15 0.05 - 0.25	70 - 120	0.50 - 1.50 1.50 - 2.50	0.01 - 0.06 0.03 - 0.12
Acier Stahl < 800 N/mm <sup>2</sup> Steel	<b>P</b> 60 - 120	0.05 - 1.0 1.0 - 4.0	0.01 - 0.10 0.05 - 0.20	60 - 100	0.50 - 1.50 1.50 - 2.50	0.01 - 0.05 0.03 - 0.10
Acier Stahl > 800 N/mm <sup>2</sup> Steel	<b>P</b> 50 - 100	0.05 - 1.0 1.0 - 3.0	0.01 - 0.08 0.05 - 0.15	40 - 80	0.50 - 1.50 1.50 - 2.50	0.01 - 0.04 0.03 - 0.08
Acier inoxydable Rostfreistahl Stainless steel	<b>M</b> 60 - 120	0.05 - 1.0 1.0 - 3.0	0.01 - 0.08 0.05 - 0.15	60 - 100	0.50 - 1.50 1.50 - 2.50	0.01 - 0.04 0.03 - 0.08
Aluminium Si <12%	<b>N</b> 200 - 1000	0.05 - 1.0 1.0 - 4.0	0.01 - 0.20 0.05 - 0.40	180 - 400	0.50 - 1.50 1.50 - 2.50	0.01 - 0.10 0.03 - 0.20
Aluminium Si >12%	<b>N</b> 180 - 800	0.05 - 1.0 1.0 - 4.0	0.01 - 0.20 0.05 - 0.40	150 - 300	0.50 - 1.50 1.50 - 2.50	0.01 - 0.10 0.03 - 0.20
Cuivre, laiton, bronze Kupfer, Messing, Bronze Copper, brass, bronze	<b>N</b> 100 - 500	0.05 - 1.0 1.0 - 4.0	0.01 - 0.20 0.05 - 0.35	100 - 300	0.50 - 1.50 1.50 - 2.50	0.01 - 0.10 0.03 - 0.20
Titane Titan Titanium	<b>S</b> 30 - 70	0.05 - 1.0 1.0 - 4.0	0.01 - 0.08 0.05 - 0.15	30 - 50	0.50 - 1.50 1.50 - 2.50	0.01 - 0.03 0.03 - 0.06

Nuances

Sorten

Grades

### TiAlN

μK20 + revêtement PVD  
μK20 + PVD Beschichtung  
μK20 + PVD coating

- excellente nuance universelle
- 1<sup>er</sup> choix pour l'usinage des aciers, aciers inoxydables et alliages de titane
- très bonne résistance à la température

- beste Universalsorte
- für die Bearbeitung von Stahl, rostfreiem Stahl und Titanlegierungen bestens geeignet
- sehr gute Warmfestigkeit

- best universal grade
- first choice for steel, stainless steel and titanium alloys machining
- very good heat resistance

### N (μK20)

non revêtu  
unbeschichtet  
uncoated

- nuance micro-grain tenace
- supporte les coupes interrompues et autres conditions d'usinage défavorables

- zähe Feinkornsorte
- für unterbrochene Schnitte und andere ungünstige Bearbeitungsbedingungen geeignet

- tough micro-grain grade
- suitable for interrupted cut and other unfavorable machining conditions

### HTA

μK10 + revêtement PVD  
μK10 + PVD Beschichtung  
μK10 + PVD coating

- nuance très résistante à l'usure
- pour l'usinage en finition dans des conditions favorables des aciers, aciers inoxydables et alliages de titane

- sehr verschleissfeste Sorte
- für die Feinbearbeitung von Stahl, rostfreiem Stahl und Titanlegierungen bei guten Bearbeitungsbedingungen

- very wear resistant grade
- for light machining of steel, stainless steel and titanium alloys under favorable machining conditions

### HN (μK10)

non revêtu  
unbeschichtet  
uncoated

- nuance micro-grain très résistante à l'usure
- recommandé pour l'usinage du titane faiblement allié
- déconseillé en cas de coupe interrompue et autres conditions d'usinage défavorables

- verschleissfeste Feinkornsorte
- für die Bearbeitung von niedrig legiertem Titan empfehlenswert
- für unterbrochene Schnitte und andere ungünstige Bearbeitungsbedingungen nicht geeignet

- wear resistant micro-grain grade
- suitable for the machining of low alloyed titanium
- not suitable for interrupted cut and other unfavorable machining conditions

L

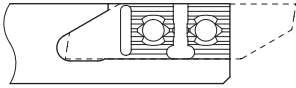

R

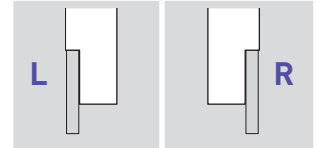
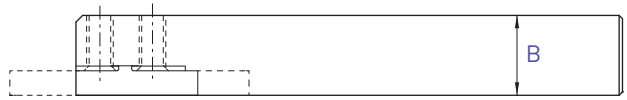
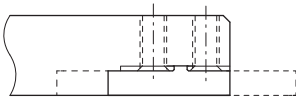
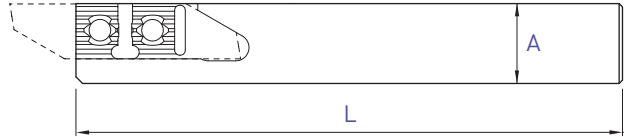

A x B	L	Art. N°	Art. N°
8 x 8	115	<b>630-8</b>	<b>640-8</b>
10 x 10	115	<b>630-10</b>	<b>640-10</b>
10 x 10	50	<b>630-10-50</b>	<b>640-10-50</b>
12 x 12	130	<b>630-12</b>	<b>640-12</b>
12 x 12	90	<b>630-12-90</b>	<b>640-12-90</b>
12.7 x 12.7	130	<b>630-12.7</b>	<b>640-12.7</b>
16 x 16	130	<b>630-16</b>	<b>640-16</b>
16 x 16	75	<b>630-16-75</b>	<b>640-16-75</b>
20 x 20	120	<b>630-20</b>	<b>640-20</b>

Chaque support est livré avec vis et clé.  
 Jeder Halter wird mit Spannschraube(n) und Schlüssel geliefert.  
 Screw(s) and key are included with each tool holder.

Porte-outils avec arrosage intégré  
 Halter mit integrierter Kühlmittelzufuhr  
 Holders with integrated coolant supply

630-JET / 640-JET

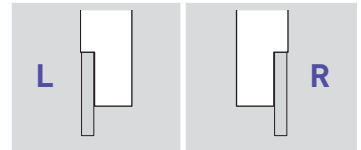
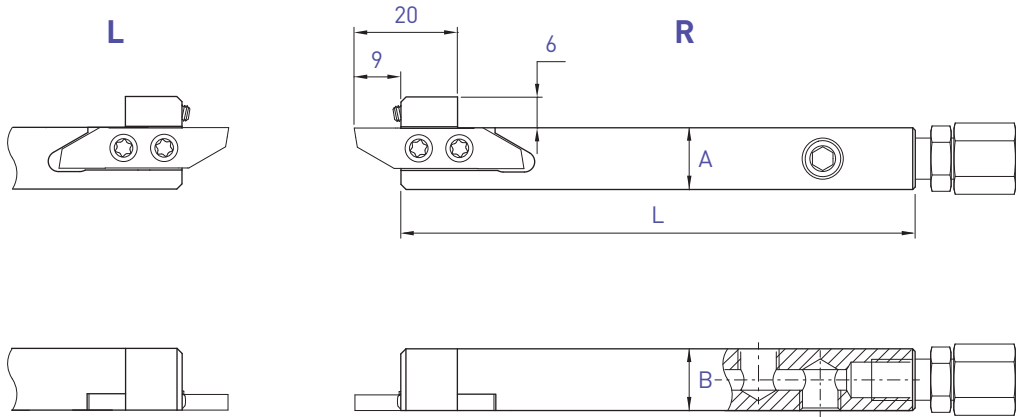

A x B	L	Art. N°	Art. N°
10 x 12	100	630-1012-JET	640-1012-JET
12 x 12	100	630-12-JET	640-12-JET
12.7 x 12.7	100	630-12.7-JET	640-12.7-JET
16 x 16	100	630-16-JET	640-16-JET
20 x 20	100	630-20-JET	640-20-JET

Chaque support est livré avec vis, clé, raccord droit et buse d'arrosage Ø 1.5 mm.  
 Jeder Halter wird mit Spannschraube(n), Schlüssel, gerader Kühlmittelanschluss und Kühlmitteldüse Ø 1.5 mm geliefert.  
 Screw(s), key, straight connector and coolant nozzle Ø 1.5 mm are included with each tool holder.



**L**

**R**

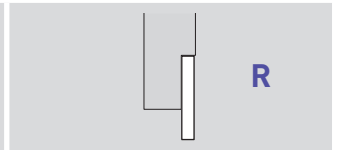
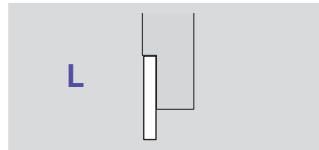
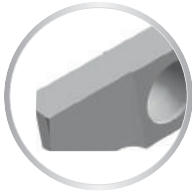
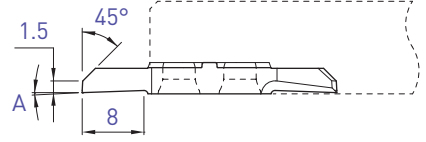
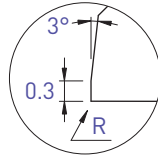
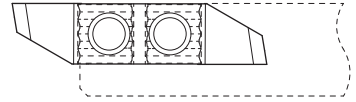
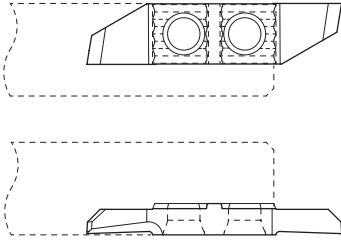

A	R	Art. N°	TiAlN N [µk20]	HTA HN [µk10]	Art. N°	TiAlN N [µk20]	HTA HN [µk10]
0°	0	632	■ ■		642	■ ■	□ □
0°	0.08	-			642-R08	■ ■	□ □
0°	0.15	-			642-R15	■ ■	□ □
2°	0	632-2°	■ ■		642-2°	■ ■	□ □
2°	0.08	-			642-2°-R08	■ ■	□ □
2°	0.15	-			642-2°-R15	■ ■	□ □

Tournage avant  
Vorwärts drehen  
Front turning

632X / 642X

L

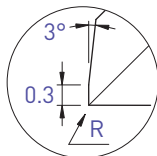
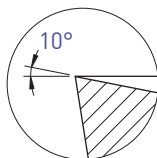
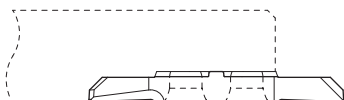
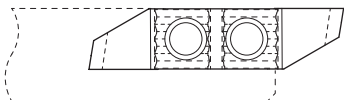

R

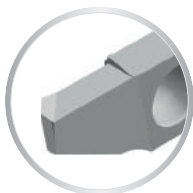
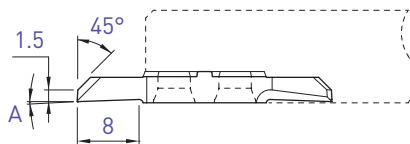
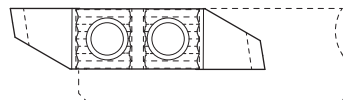

L



R



A	R	Art. N°	TiAlN N [µk20]	HTA HN [µk10]	Art. N°	TiAlN N [µk20]	HTA HN [µk10]
0°	0	632X10	■ ■		642X10	■ ■	□ □
0°	0.08	-			642X10-R08	■ ■	□ □
0°	0.15	-			642X10-R15	■ ■	□ □
2°	0	632X10-2°	■ ■		642X10-2°	■ ■	□ □
2°	0.08	-			642X10-2°-R08	■ ■	□ □
2°	0.15	-			642X10-2°-R15	■ ■	□ □

**Tournage multifonction**

**Mehrweck drehen**

**Multifunction turning**

**632S / 642S**

**L**

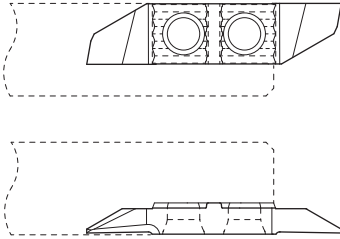

**R**

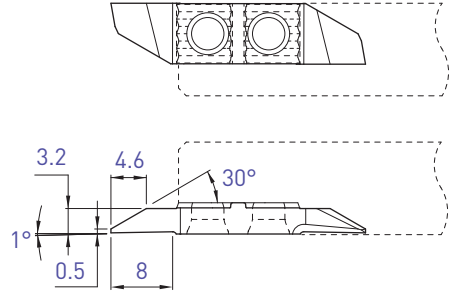

Tournage avant  
Vorwärts drehen  
Front turning

L				R			
Art. N°	TiAlN N (µk20)	HTA	HN (µk10)	Art. N°	TiAlN N (µk20)	HTA	HN (µk10)
632S05	■ ■			642S05	■ ■	□ □	

Tournage multifonction

Mehrweck drehen

Multifunction turning

633S / 643S

L

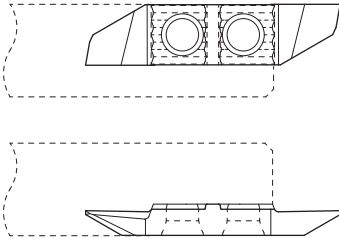

R

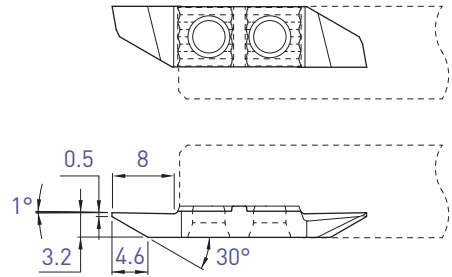

Tournage arrière  
Rückwärts drehen  
Back turning

L				R			
Art. N°	Ti/AlN N [µk20]	HTA	HN [µk10]	Art. N°	Ti/AlN N [µk20]	HTA	HN [µk10]
633S05	■ ■			643S05	■ ■	□ □	

L

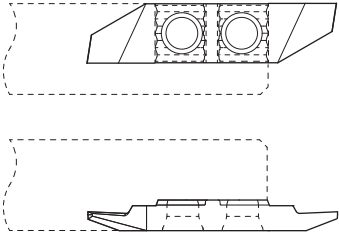

R

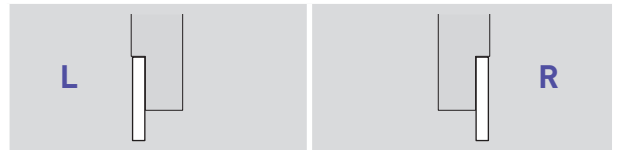
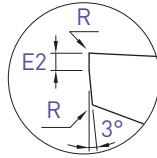
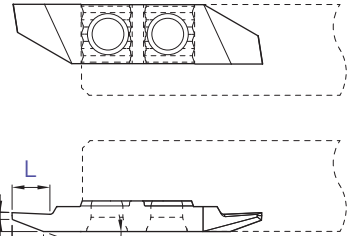

E1	E2	L	L1	E	R	Art. N°	TiAlN N [µk20]	HTA HN [µk10]	Art. N°	TiAlN N [µk20]	HTA HN [µk10]
0.5	0.25	3	2.8	1.5	0	633-0.5	■ ■		643-0.5	■ ■	□ □
0.5	0.25	3	2.8	1.5	0.08	-			643-0.5-R08	■ ■	□ □
0.8	0.40	4.5	3.3	2.0	0	-			643-0.8	■ ■	□ □
0.8	0.40	4.5	3.3	2.0	0.08	-			643-0.8-R08	■ ■	□ □
1.0	0.40	5	4.2	2.5	0	-			643-1.0	■ ■	□ □
1.0	0.40	5	4.2	2.5	0.08	-			643-1.0-R08	■ ■	□ □
1.5	0.50	6	4.2	3.0	0	-			643-1.5	■ ■	□ □
1.5	0.50	6	4.2	3.0	0.08	-			643-1.5-R08	■ ■	□ □

Tournage arrière  
 Rückwärts drehen  
 Back turning

633X / 643X

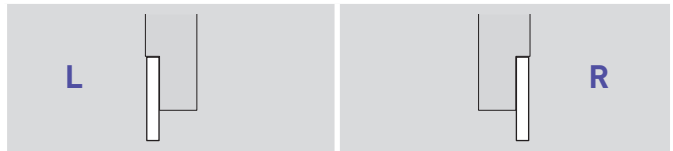
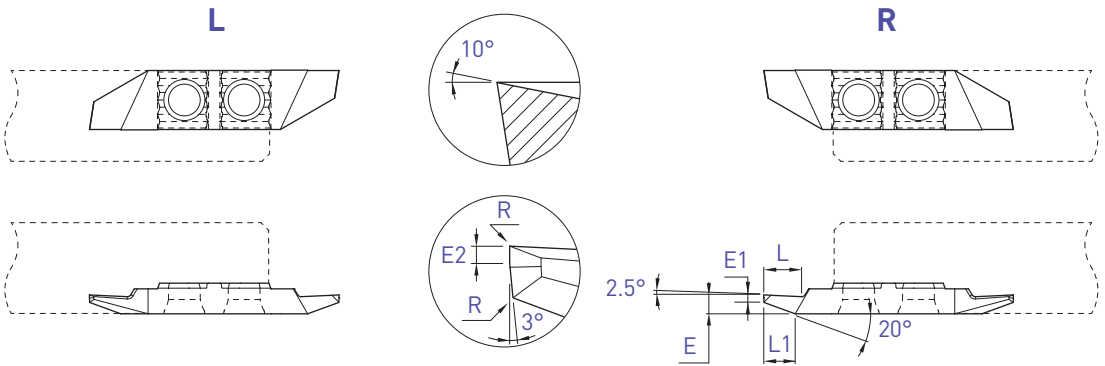

E1	E2	L	L1	E	R	Art. N°	TiAlN N [µk20]	HTA HN [µk10]	Art. N°	TiAlN N [µk20]	HTA HN [µk10]
0.5	0.25	3	2.8	1.5	0	633X10-0.5	■ ■		643X10-0.5	■ ■	□ □
0.5	0.25	3	2.8	1.5	0.08	-			643X10-0.5-R08	■ ■	□ □
0.8	0.40	4.5	3.3	2.0	0	-			643X10-0.8	■ ■	□ □
0.8	0.40	4.5	3.3	2.0	0.08	-			643X10-0.8-R08	■ ■	□ □
1.0	0.40	5	4.2	2.5	0	-			643X10-1.0	■ ■	□ □
1.0	0.40	5	4.2	2.5	0.08	-			643X10-1.0-R08	■ ■	□ □
1.5	0.50	6	4.2	3.0	0	-			643X10-1.5	■ ■	□ □
1.5	0.50	6	4.2	3.0	0.08	-			643X10-1.5-R08	■ ■	□ □

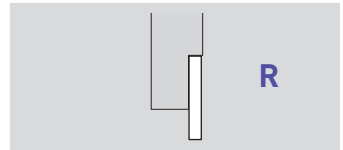
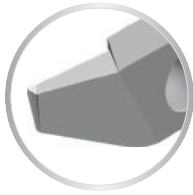
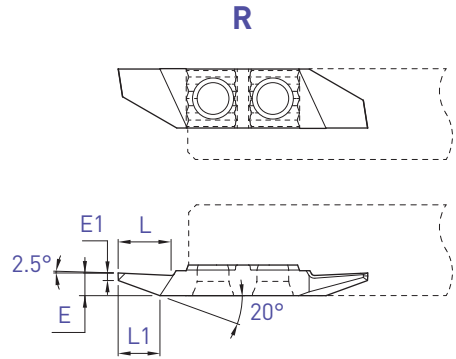
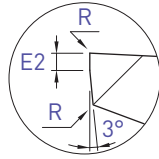
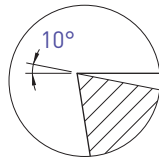

E1	E2	L	L1	E	R	Art. N°	TiAlN N [µk20]	HTA	HN [µk10]
1.0	0.4	7	5.5	3.0	0	643X10S-1.0	■ ■	□ □	
1.0	0.4	7	5.5	3.0	0.08	643X10S-1.0-R08	■ ■	□ □	

Tournage arrière  
 Rückwärts drehen  
 Back turning

643VX8

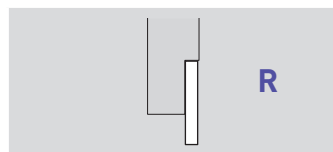
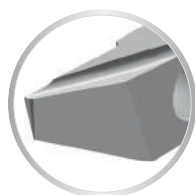
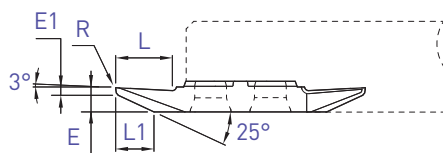
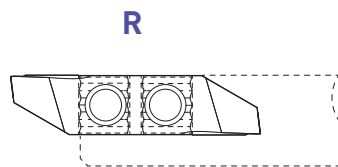
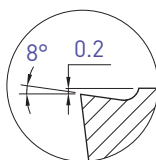

E1	L	L1	E	R	Art. N°	TiAlN N [µk20]	HTA	HN [µk10]
1.0	7.5	5.0	3.2	0	643VX8	■ ■	□ □	
1.0	7.5	5.0	3.2	0.08	643VX8-R08	■ ■	□ □	



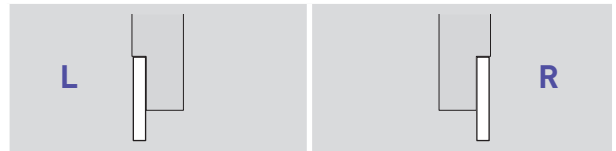
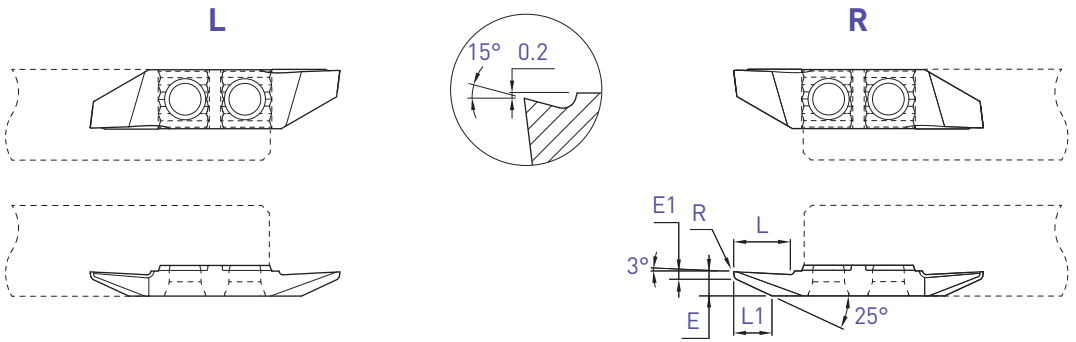

E1	L	L1	E	R	Art. N°	TiAlN N [µk20]	HTA HN [µk10]	Art. N°	TiAlN N [µk20]	HTA HN [µk10]
0.6	7.5	5.2	3.2	0	<b>633VX15</b>	■ ■		<b>643VX15</b>	■ ■	□ □
0.6	7.5	5.2	3.2	0.08	-			<b>643VX15-R08</b>	■ ■	□ □

Tournage arrière  
 Rückwärts drehen  
 Back turning

643VUX

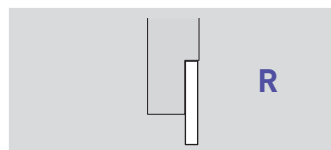
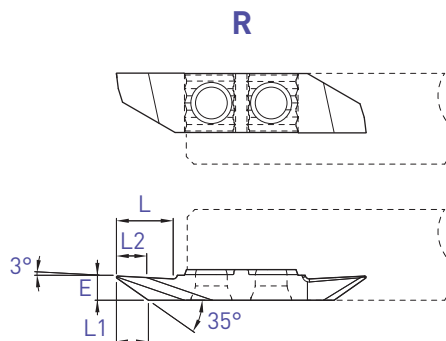
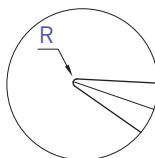
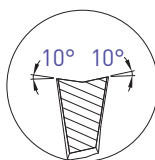

L	L1	L2	E	R	Art. N°	TiAlN N [µk20]	HTA	HN [µk10]
7.5	4.2	4.0	3.2	0.15	643VUX10-R15	■ ■	□ □	
7.5	3.8	3.8	3.2	0.35	643VUX10-R35	■ ■	□ □	

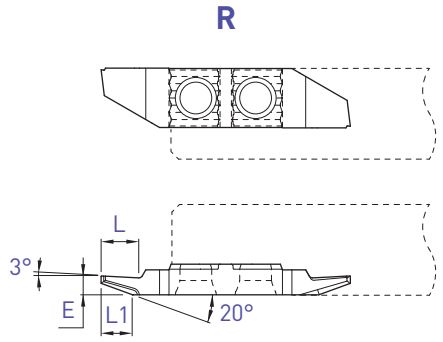
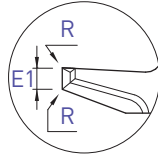
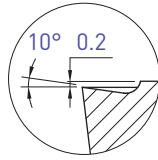

Pour un meilleur contrôle des copeaux  
Für eine bessere Spankontrolle  
For a better chip control

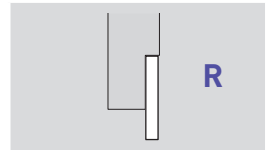

E1	L	L1	E	R	Art. N°	TiAlN N (µk20)
1.0	5	4	2.5	0.01	643ZX10-1.0	■
1.0	5	4	2.5	0.08	643ZX10-1.0-R08	■

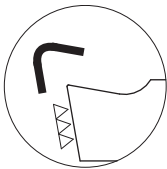

Arête de coupe honée  
Gehonte Schneidkante  
Honed edge

f min: 0.02 mm/U

Fonçage-tournage

Einstecken und drehen

Grooving and turning

634 / 644

L

R

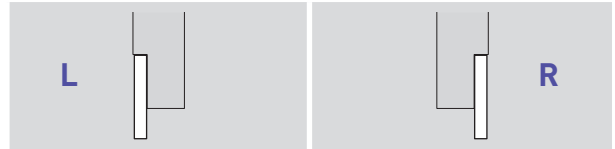
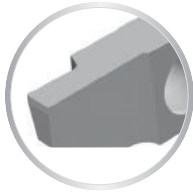
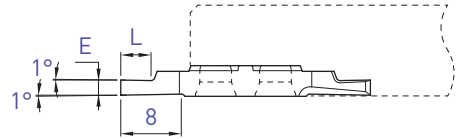
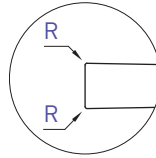
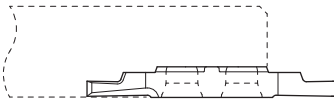
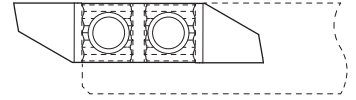
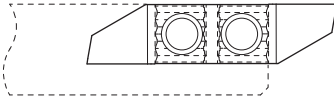

E	L	R	Art. N°	TiAlN N (µk20)	HTA HN (µk10)	Art. N°	TiAlN N (µk20)	HTA HN (µk10)
0.5	1.5	0	634-0.5	■ ■		644-0.5	■ ■	□ □
0.6	1.8	0	-			644-0.6	■ ■	□ □
0.75	2	0	-			644-0.75	■ ■	□ □
0.8	2	0	634-0.8	■ ■		644-0.8	■ ■	□ □
0.9	2.5	0	-			644-0.9	■ ■	□ □
0.95	3	0	-			644-0.95	■ ■	□ □
1.0	2.5	0	634-1.0	■ ■		644-1.0	■ ■	□ □
1.0	2.5	0.08	-			644-1.0-R08	■ ■	□ □
1.2	3	0	634-1.2	■ ■		644-1.2	■ ■	□ □
1.2	3	0.08	-			644-1.2-R08	■ ■	□ □
1.5	3	0	634-1.5	■ ■		644-1.5	■ ■	□ □
1.5	3	0.08	-			644-1.5-R08	■ ■	□ □
1.5	3	0.15	-			644-1.5-R15	■ ■	□ □
1.8	4	0	-			644-1.8	■ ■	□ □
2.0	4	0	634-2.0	■ ■		644-2.0	■ ■	□ □
2.0	4	0.08	-			644-2.0-R08	■ ■	□ □
2.0	4	0.15	-			644-2.0-R15	■ ■	□ □
2.5	6	0	634-2.5	■ ■		644-2.5	■ ■	□ □
2.5	6	0.08	-			644-2.5-R08	■ ■	□ □
2.5	6	0.15	-			644-2.5-R15	■ ■	□ □
3	6	0	634-3.0	■ ■		644-3.0	■ ■	□ □
3	6	0.08	-			644-3.0-R08	■ ■	□ □
3	6	0.15	-			644-3.0-R15	■ ■	□ □

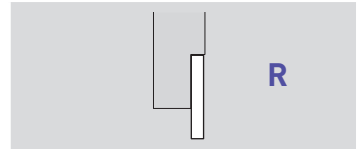
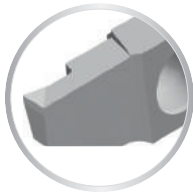
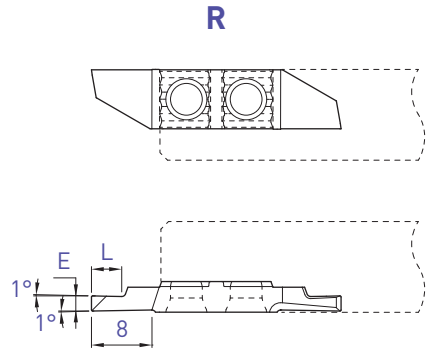
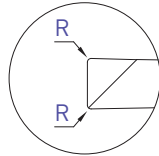
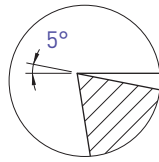

E	L	R	Art. N°	TiAlN N (µk20)	HTA	HN (µk10)
1.5	3	0.08	644X5-1.5-R08	■ ■	□ □	
2	4	0.08	644X5-2.0-R08	■ ■	□ □	
2	4	0.15	644X5-2.0-R15	■ ■	□ □	
2.5	6	0.08	644X5-2.5-R08	■ ■	□ □	
2.5	6	0.15	644X5-2.5-R15	■ ■	□ □	
3	6	0.08	644X5-3.0-R08	■ ■	□ □	
3	6	0.15	644X5-3.0-R15	■ ■	□ □	

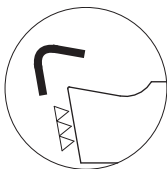
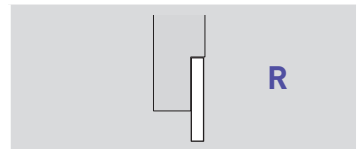

Arête de coupe honée  
Gehonte Schneidkante  
Honed edge

f min: 0.02 mm/U

E	L	R	Art. N°	TiAlN N (µk20)	HTA	HN (µk10)
1.5	3	0.08	644X5-1.5-R08-EP	■ ■		
2	4	0.08	644X5-2.0-R08-EP	■ ■		
2	4	0.15	644X5-2.0-R15-EP	■ ■		
2.5	6	0.08	644X5-2.5-R08-EP	■ ■		
2.5	6	0.15	644X5-2.5-R15-EP	■ ■		
3	6	0.08	644X5-3.0-R08-EP	■ ■		
3	6	0.15	644X5-3.0-R15-EP	■ ■		

Fonçage-tournage

Einstecken und drehen

Grooving and turning

634X10 / 644X10

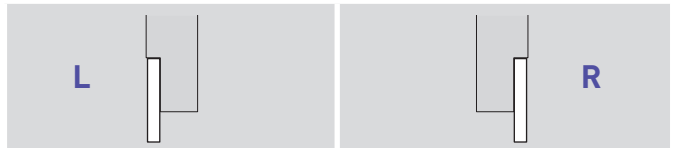
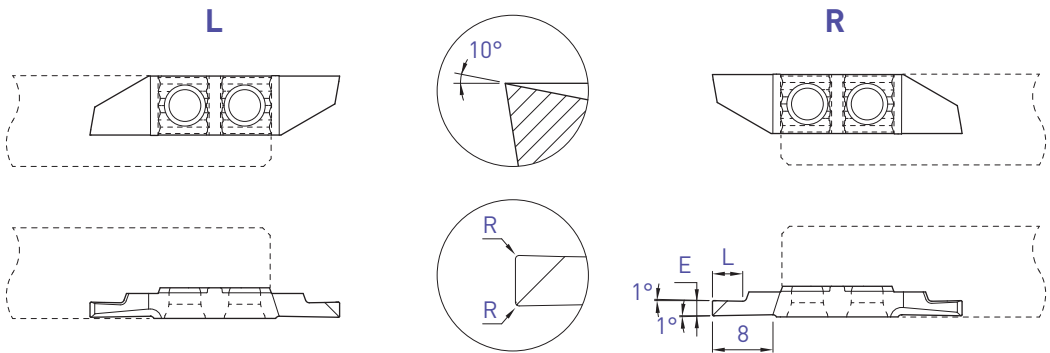

E	L	R	Art. N°	TiAlN N (µk20)	HTA HN (µk10)	Art. N°	TiAlN N (µk20)	HTA HN (µk10)
0.8	2	0	634X10-0.8	■ ■		644X10-0.8	■ ■ □ □	
1.0	2.5	0	634X10-1.0	■ ■		644X10-1.0	■ ■ □ □	
1.0	2.5	0.08	634X10-1.0-R08	■ ■		644X10-1.0-R08	■ ■ □ □	
1.2	3	0	-			644X10-1.2	■ ■ □ □	
1.2	3	0.08	-			644X10-1.2-R08	■ ■ □ □	
1.5	3	0	634X10-1.5	■ ■		644X10-1.5	■ ■ □ □	
1.5	3	0.08	634X10-1.5-R08	■ ■		644X10-1.5-R08	■ ■ □ □	
1.5	3	0.15	634X10-1.5-R15	■ ■		644X10-1.5-R15	■ ■ □ □	
1.8	4	0	-			644X10-1.8	■ ■ □ □	
2	4	0	634X10-2.0	■ ■		644X10-2.0	■ ■ □ □	
2	4	0.08	634X10-2.0-R08	■ ■		644X10-2.0-R08	■ ■ □ □	
2	4	0.15	634X10-2.0-R15	■ ■		644X10-2.0-R15	■ ■ □ □	
2.5	6	0	634X10-2.5	■ ■		644X10-2.5	■ ■ □ □	
2.5	6	0.08	634X10-2.5-R08	■ ■		644X10-2.5-R08	■ ■ □ □	
2.5	6	0.15	634X10-2.5-R15	■ ■		644X10-2.5-R15	■ ■ □ □	
3	6	0	634X10-3.0	■ ■		644X10-3.0	■ ■ □ □	
3	6	0.08	634X10-3.0-R08	■ ■		644X10-3.0-R08	■ ■ □ □	
3	6	0.15	634X10-3.0-R15	■ ■		644X10-3.0-R15	■ ■ □ □	

■ = disponible / verfügbar / available  
 □ = selon disponibilité du stock / jenach Lagerverfügbarkeit / depending on stock availability

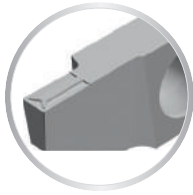
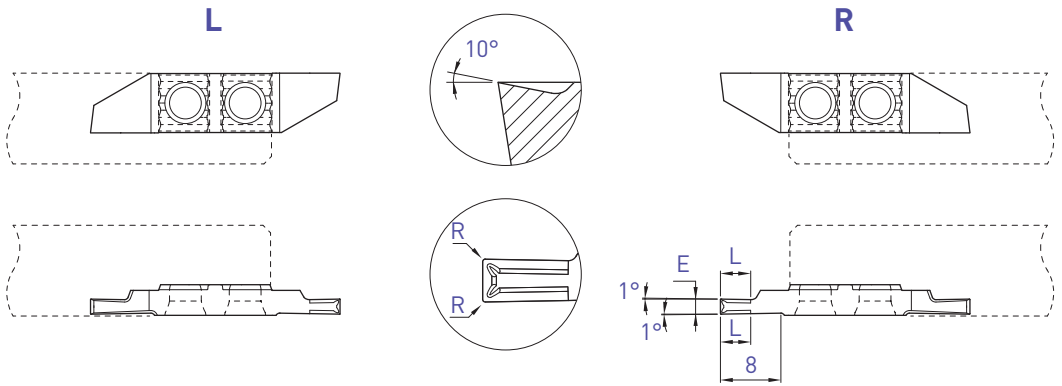

Pour un meilleur contrôle des copeaux  
Für eine bessere Spankontrolle  
For a better chip-control

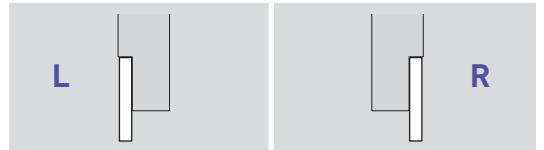

E	L	R	Art. N°	TiAlN N (µk20)	Art. N°	TiAlN N (µk20)
1.0	2.5	0.01	634ZXB10-1.0	■	644ZXB10-1.0	■
1.5	4	0.01	634ZXB10-1.5	■	644ZXB10-1.5	■
1.5	4	0.08	634ZXB10-1.5-R08	■	644ZXB10-1.5-R08	■
2.0	4	0.01	634ZXB10-2.0	■	644ZXB10-2.0	■
2.0	4	0.08	634ZXB10-2.0-R08	■	644ZXB10-2.0-R08	■
2.0	4	0.15	634ZXB10-2.0-R15	■	644ZXB10-2.0-R15	■
2.5	5	0.08	634ZXB10-2.5-R08	■	644ZXB10-2.5-R08	■
2.5	5	0.15	634ZXB10-2.5-R15	■	644ZXB10-2.5-R15	■
3.0	6	0.08	634ZXB10-3.0-R08	■	644ZXB10-3.0-R08	■
3.0	6	0.15	634ZXB10-3.0-R15	■	644ZXB10-3.0-R15	■
3.0	6	0.35	634ZXB10-3.0-R35	■	644ZXB10-3.0-R35	■

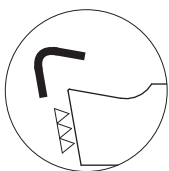

Arête de coupe honée  
Gehonte Schneidkante  
Honed edge

f min: 0.02 mm/U

Fonçage-tournage

Einstecken und drehen

Grooving and turning

634ZXT / 644ZXT

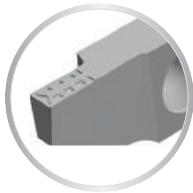
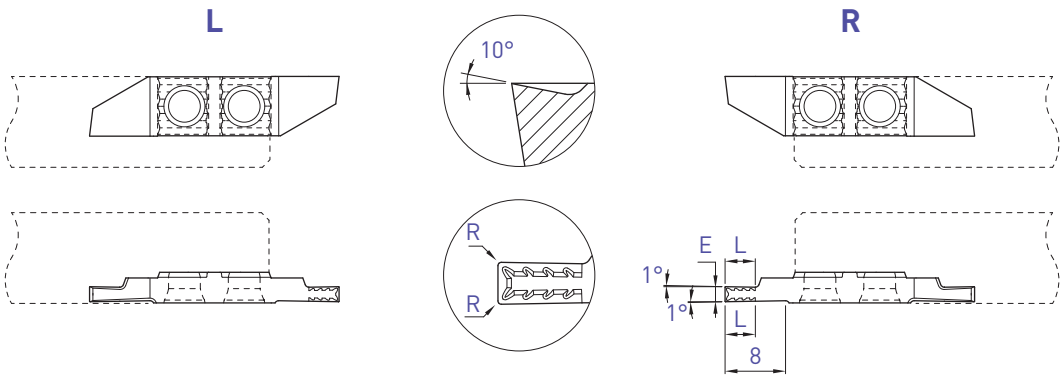

Pour un meilleur contrôle des copeaux  
Für eine bessere Spankontrolle  
For a better chip-control

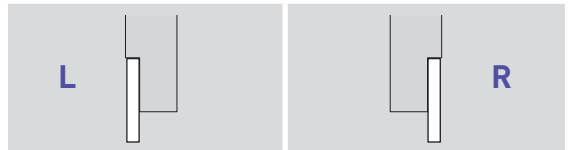

E	L	R	Art. N°	TiAlN N (µm <sup>20</sup> )	Art. N°	TiAlN N (µm <sup>20</sup> )
1.0	2.5	0.01	634ZXT10-1.0	■	644ZXT10-1.0	■
1.5	4	0.01	634ZXT10-1.5	■	644ZXT10-1.5	■
1.5	4	0.08	634ZXT10-1.5-R08	■	644ZXT10-1.5-R08	■
2.0	4	0.01	634ZXT10-2.0	■	644ZXT10-2.0	■
2.0	4	0.08	634ZXT10-2.0-R08	■	644ZXT10-2.0-R08	■
2.0	4	0.15	634ZXT10-2.0-R15	■	644ZXT10-2.0-R15	■
2.5	5	0.08	634ZXT10-2.5-R08	■	644ZXT10-2.5-R08	■
2.5	5	0.15	634ZXT10-2.5-R15	■	644ZXT10-2.5-R15	■
3.0	6	0.08	634ZXT10-3.0-R08	■	644ZXT10-3.0-R08	■
3.0	6	0.15	634ZXT10-3.0-R15	■	644ZXT10-3.0-R15	■
3.0	6	0.35	-		644ZXT10-3.0-R35	■

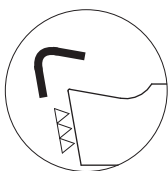

Arête de coupe honée  
Gehonte Schneidkante  
Honed edge

f min: 0.02 mm/U



L

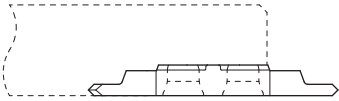
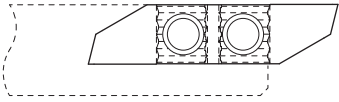

R

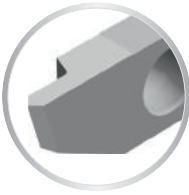
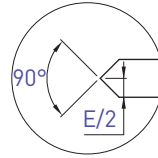
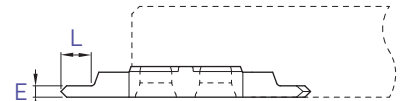
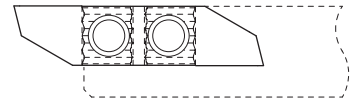

L



R



E	L	Art. N°	TiAlN N (µk20)	Art. N°	TiAlN N (µk20)
1.5	4	635-90-1.5	■ ■	645-90-1.5	■ ■

Chanfreinage

Anfasen

Chamfering

635X-90 / 645X-90

L

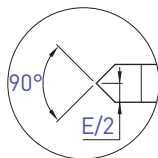
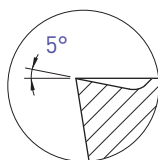
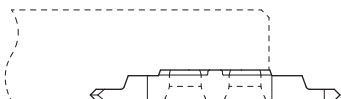
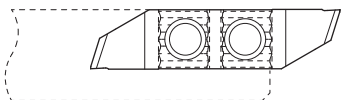

R

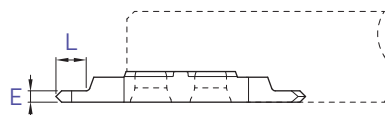
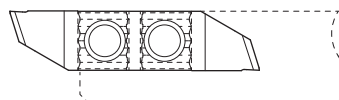

L



R



E	L	Art. N°	TiAlN N (µk<20)	Art. N°	TiAlN N (µk<20)
1.5	4	635X5-90-1.5	■ ■	645X5-90-1.5	■ ■

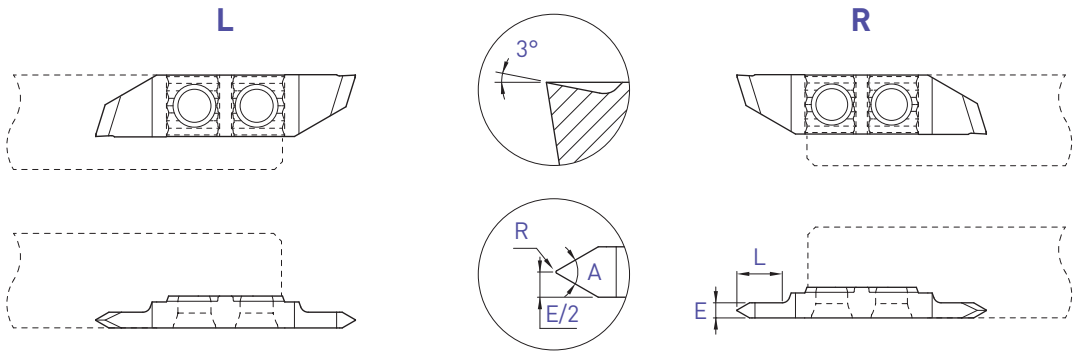

Profil partiel  
Teilprofil  
Partial profile

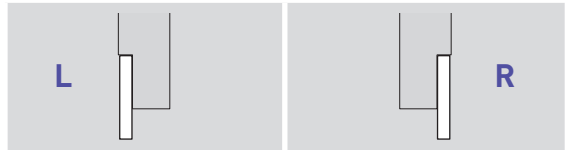

A	E	L	R	Art. N°	TiAlN N (µk20)	Art. N°	TiAlN N (µk20)
55°	1.5	4	0	636X3-55-1.5	■ ■	646X3-55-1.5	■ ■
55°	2.0	6	0.03	636X3-55-2.0-R03	■ ■	646X3-55-2.0-R03	■ ■
60°	1.5	4	0	636X3-60-1.5	■ ■	646X3-60-1.5	■ ■
60°	2.0	6	0.03	636X3-60-2.0-R03	■ ■	646X3-60-2.0-R03	■ ■
60°	2.0	6	0.06	636X3-60-2.0-R06	■ ■	646X3-60-2.0-R06	■ ■
60°	3.0	8	0.06	636X3-60-3.0-R06	■ ■	646X3-60-3.0-R06	■ ■
60°	3.0	8	0.12	636X3-60-3.0-R12	■ ■	646X3-60-3.0-R12	■ ■

Filetage

Gewinde drehen

Threading

636X-M / 646X-M

L

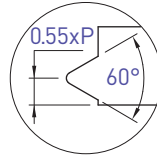
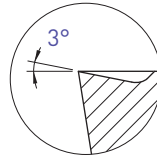
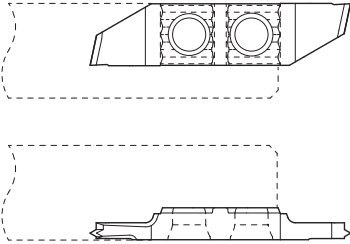

R

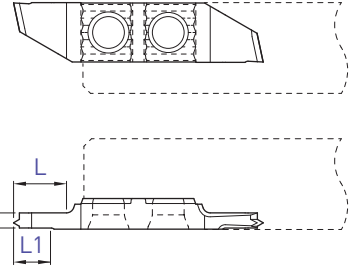

Profil complet métrique  
Metrisches Vollprofil  
Metric full profile

L



R



E	L	L1	Pas Steigung Pitch P	Art. N°	TiAlN N (µk20)	Art. N°	TiAlN N (µk20)
1.0	3	3	0.25	636X3-M-0.25	■ ■	646X3-M-0.25	■ ■
1.0	3	3	0.30	636X3-M-0.30	■ ■	646X3-M-0.30	■ ■
1.0	3	3	0.35	636X3-M-0.35	■ ■	646X3-M-0.35	■ ■
1.0	3	3	0.40	636X3-M-0.40	■ ■	646X3-M-0.40	■ ■
1.0	3	3	0.45	636X3-M-0.45	■ ■	646X3-M-0.45	■ ■
1.0	3	3	0.50	636X3-M-0.50	■ ■	646X3-M-0.50	■ ■
1.5	5	5	0.60	636X3-M-0.60	■ ■	646X3-M-0.60	■ ■
1.5	5	5	0.70	636X3-M-0.70	■ ■	646X3-M-0.70	■ ■
1.5	5	5	0.75	636X3-M-0.75	■ ■	646X3-M-0.75	■ ■
1.5	5	5	0.80	636X3-M-0.80	■ ■	646X3-M-0.80	■ ■
2.0	7	5	1.00	636X3-M-1.00	■ ■	646X3-M-1.00	■ ■
2.0	7	5	1.25	636X3-M-1.25	■ ■	646X3-M-1.25	■ ■
2.0	7	5	1.50	636X3-M-1.50	■ ■	646X3-M-1.50	■ ■

# PRO-LINE

Plaquettes à rayon  
 Radius Wendeplatten  
 Radius inserts

637 / 647

L

R

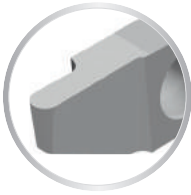
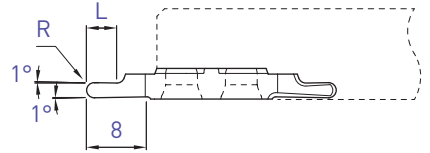
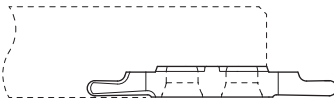
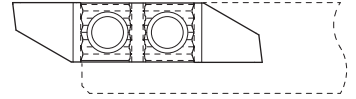
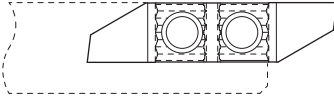

L

R

R	L	Art. N°	TiAlN N (µk20)	HTA HN (µk10)	Art. N°	TiAlN N (µk20)	HTA HN (µk10)
0.25	1.5	-			647-R0.25	■ ■	
0.4	2	-			647-R0.4	■ ■	
0.5	2.5	637-R0.5	■ ■		647-R0.5	■ ■ □ □	
0.6	2.5	-			647-R0.6	■ ■	
0.75	3	-			647-R0.75	■ ■	
0.8	3	-			647-R0.8	■ ■	
1.0	4	637-R1.0	■ ■		647-R1.0	■ ■	
1.5	6	-			647-R1.5	■ ■	

Plaquettes à rayon  
 Radius Wendplatten  
 Radius inserts

647ZX10

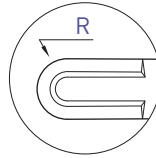
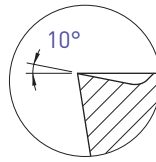

R

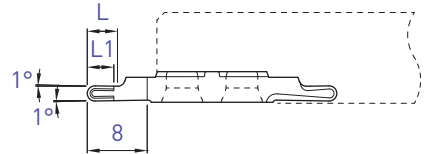
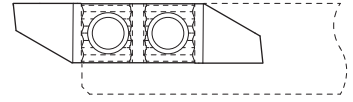

Pour un meilleur contrôle des copeaux  
 Für eine bessere Spankontrolle  
 For a better chip-control

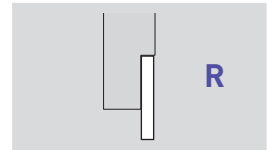

R	L	L1	Art. N°	TiAlN N (µk20)
1.0	4	3.5	647ZX10-R1.0	■
1.5	6	4	647ZX10-R1.5	■

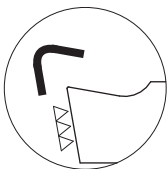

Arête de coupe honée  
 Gehonte Schneidkante  
 Honed edge

f min: 0.02 mm/U

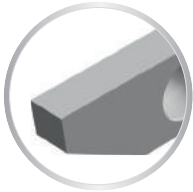
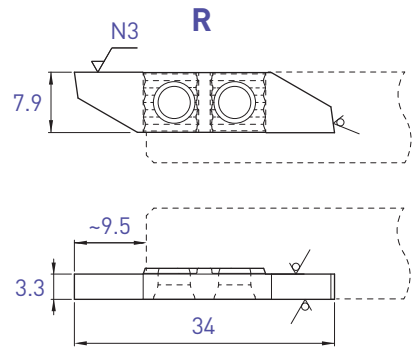
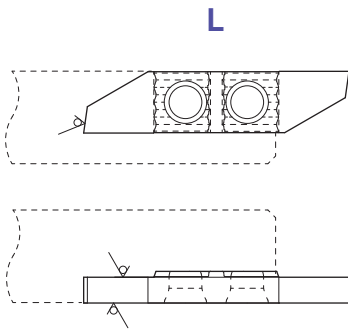

Face de coupe polie  
 Polierte Schneidfläche  
 Polished cutting face

L				R			
Art. N°	TiAlN N (µk20)	HTA	HN (µk10)	Art. N°	TiAlN N (µk20)	HTA	HN (µk10)
631-EP	■ ■	■ ■	■ ■	641-EP	■ ■	■ ■	■ ■

Porte-outils

Halter

Holder

650 / 660

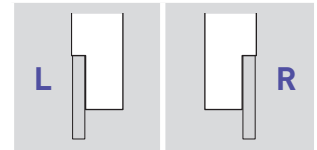
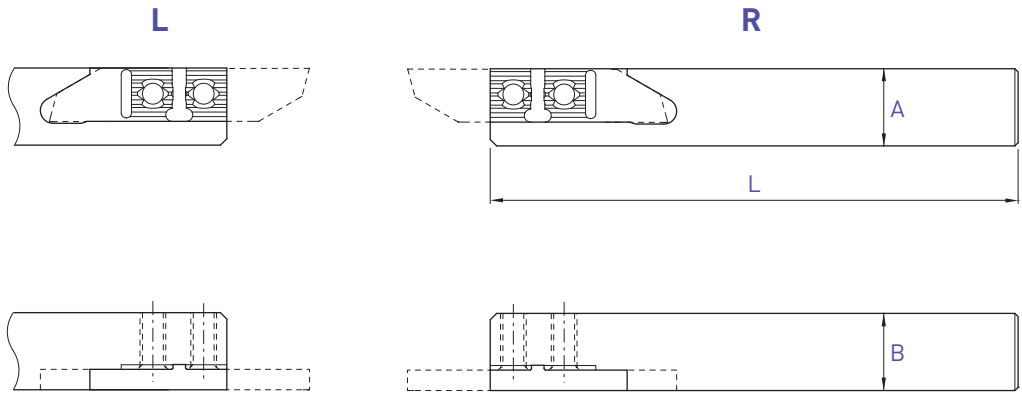

A x B	L	Art. N°	Art. N°
8 x 8	115	650-8	660-8
10 x 10	115	650-10	660-10
10 x 10	50	650-10-50	660-10-50
12 x 12	130	650-12	660-12
12 x 12	90	650-12-90	660-12-90
12.7 x 12.7	130	650-12.7	660-12.7
16 x 16	130	650-16	660-16
16 x 16	75	650-16-75	660-16-75
20 x 20	120	650-20	660-20

Chaque support est livré avec vis et clé.

Jeder Halter wird mit Spannschraube(n) und Schlüssel geliefert.

Screw(s) and key are included with each tool holder.

■ = disponible / verfügbar / available

□ = selon disponibilité du stock / jenach Lagerverfügbarkeit / depending on stock availability



Utiliser des plaquettes type 651R  
 WSP Typ 651R verwenden  
 Use inserts type 651R

Voir dès page 3.39  
 Siehe ab Seite 3.39  
 See from page 3.39

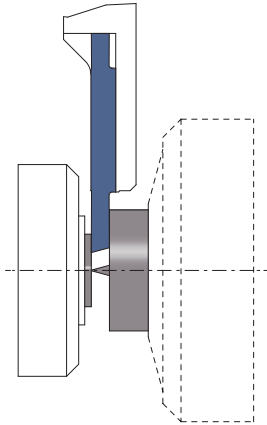
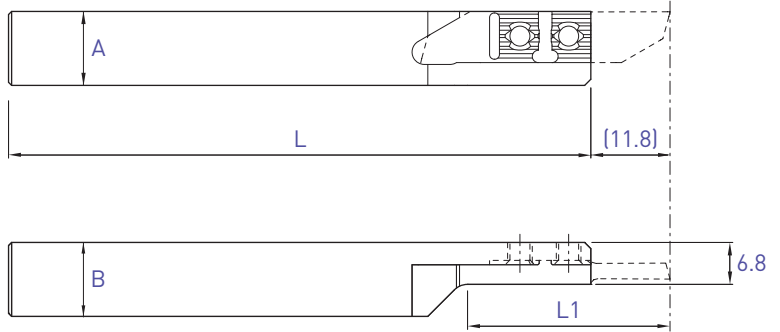

 <b>L (R)</b> Coupe à droite déportée Versetztes Rechtsschneiden Right cut off line			
A x B	L	L1	Art. N°
10 x 10	115	32	<b>650RC-10</b>
12 x 12	130	32	<b>650RC-12</b>
16 x 16	130	42	<b>650RC-16</b>

Chaque support est livré avec vis et clé.  
 Jeder Halter wird mit Spannschraube(n) und Schlüssel geliefert.  
 Screw(s) and key are included with each tool holder.

Porte-outils avec arrosage intégré  
 Halter mit integrierter Kühlmittelzufuhr  
 Holders with integrated coolant supply

650-JET / 660-JET

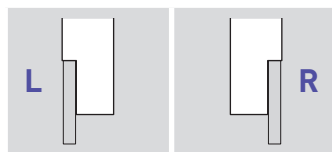
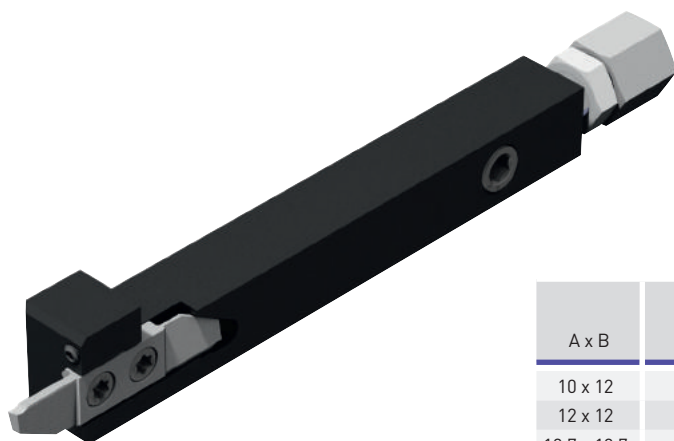
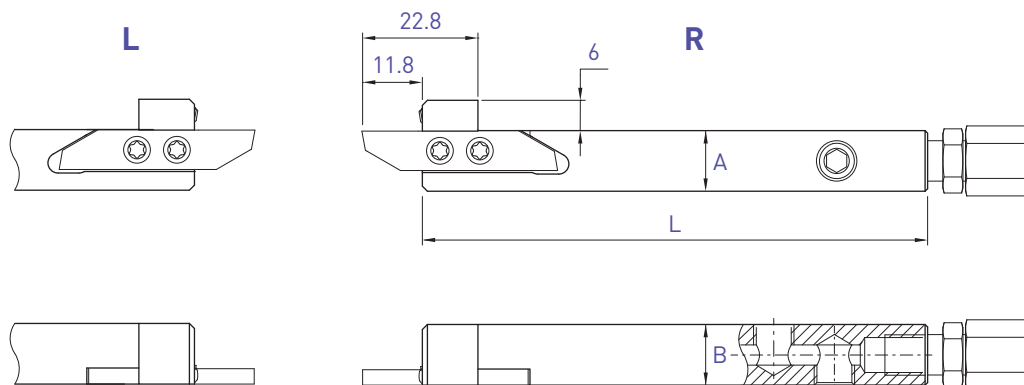

A x B	L	Art. N°	Art. N°
10 x 12	100	650-1012-JET	660-1012-JET
12 x 12	100	650-12-JET	660-12-JET
12.7 x 12.7	100	650-12.7-JET	660-12.7-JET
16 x 16	100	650-16-JET	660-16-JET
20 x 20	100	650-20-JET	660-20-JET

Chaque support est livré avec vis, clé, raccord droit et buse d'arrosage Ø 1.5 mm.

Jeder Halter wird mit Spannschraube(n), Schlüssel, gerader Kühlmittelanschluss und Kühlmitteldüse Ø 1.5 mm geliefert.

Screw(s), key, straight connector and coolant nozzle Ø 1.5 mm are included with each tool holder.

L

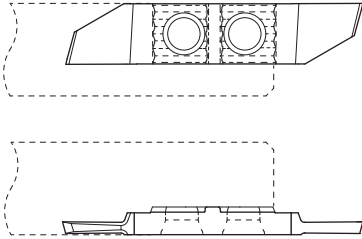

R

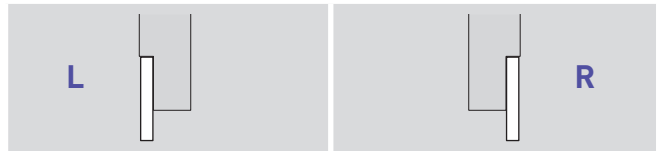
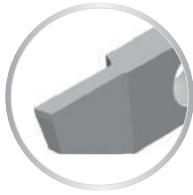
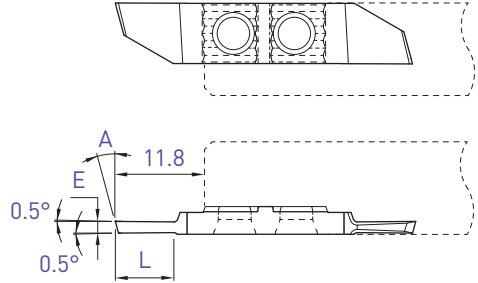

E	A	L	L				R			
			Art. N°	TiAlN N [µk20]	HTA HN [µk10]	Art. N°	TiAlN N [µk20]	HTA HN [µk10]		
0.8	20°	5	651-0.8-20°	■ ■		661-0.8-20°	■ ■	□ □		
1.0	15°	5	-			661-1.0-15°	■ ■	□ □		
1.0	20°	5	651-1.0-20°	■ ■		661-1.0-20°	■ ■	□ □		
1.2	15°	5	-			661-1.2-15°	■ ■	□ □		
1.2	20°	5	651-1.2-20°	■ ■		661-1.2-20°	■ ■	□ □		
1.5	15°	7.5	651-1.5-15°	■ ■		661-1.5-15°	■ ■	□ □		
1.5	20°	7.5	-			661-1.5-20°	■ ■	□ □		
1.8	15°	9	651-1.8-15°	■ ■		661-1.8-15°	■ ■	□ □		
2.0	15°	11	651-2.0-15°	■ ■		661-2.0-15°	■ ■	□ □		
2.5	15°	11	651-2.5-15°	■ ■		661-2.5-15°	■ ■	□ □		

Tronçonnage

Abstechen

Parting off

651XF / 661XF

L

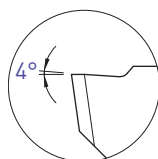
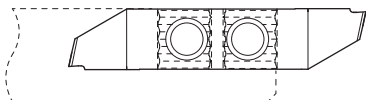

R

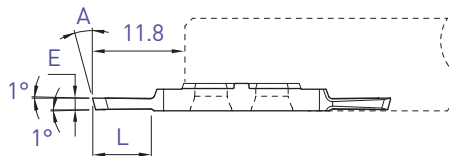
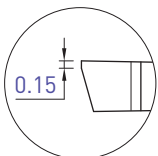
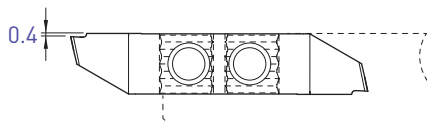

L



R



E	A	L	Art. N°	TiAlN N [µk20]	HTA HN [µk10]	Art. N°	TiAlN N [µk20]	HTA HN [µk10]
1.5	15°	7.5	651XF-1.5	■ ■		661XF-1.5	■ ■	□ □
2.0	15°	11	651XF-2.0	■ ■		661XF-2.0	■ ■	□ □

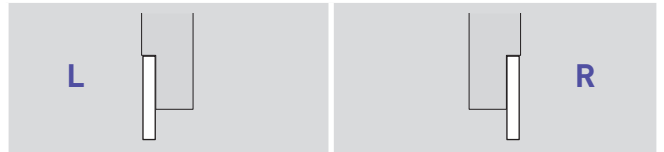
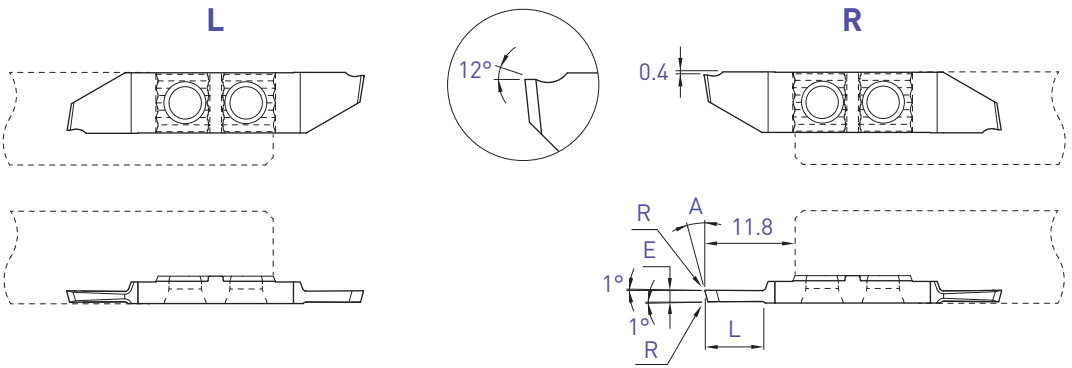

E	A	L	R	Art. N°	TiAlN N [µk20]	HTA HN [µk10]	Art. N°	TiAlN N [µk20]	HTA HN [µk10]
1.0	15°	5	0.03	651X12-1.0	■ ■		661X12-1.0	■ ■	□ □
1.5	15°	7.5	0.03	651X12-1.5	■ ■		661X12-1.5	■ ■	□ □
2.0	15°	11	0.03	651X12-2.0	■ ■		661X12-2.0	■ ■	□ □

Tronçonnage

Abstechen

Parting off

651U / 661U

L

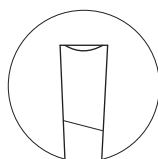
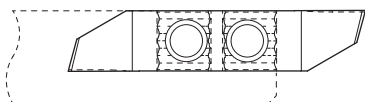

R

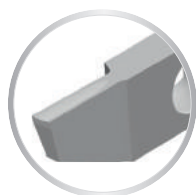
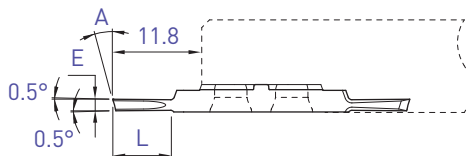
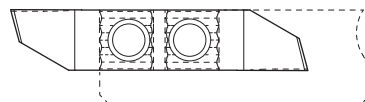

L

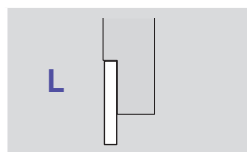

R

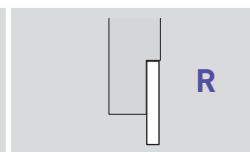

E	A	L	Art. N°	TiAlN N (µm20)	Art. N°	TiAlN N (µm20)
1.5	15°	7.5	651U-1.5	■ ■	661U-1.5	■ ■
2.0	15°	11	651U-2.0	■ ■	661U-2.0	■ ■

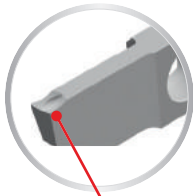
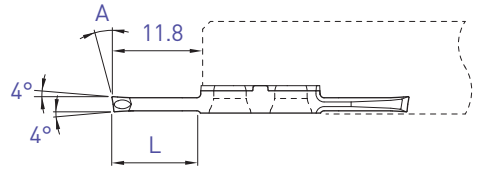
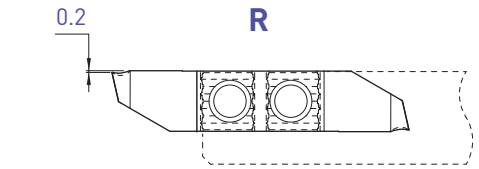
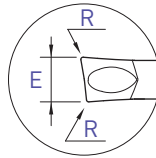
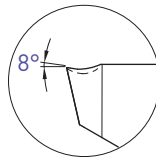

Pour un meilleur contrôle des copeaux  
Für eine bessere Spankontrolle  
For a better chip-control

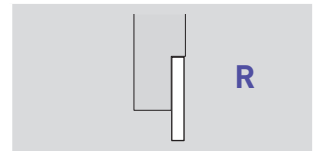
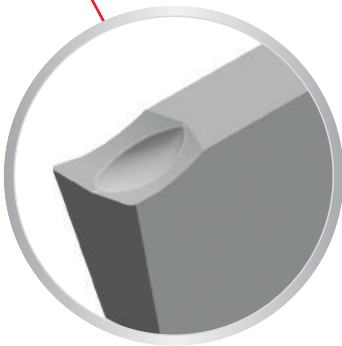

E	A	L	R	Art. N°	TiAlN N (µk20)
2.0	8°	11	0.10	661ZU8-2.0-8°-R10	■

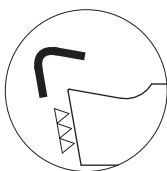

Arête de coupe honée  
Gehonte Schneidkante  
Honed edge

f min: 0.02 mm/U

Tronçonnage  
Abstechen  
Parting off

Coupe déportée  
Versetzttes Schneiden  
Cut off line

651R

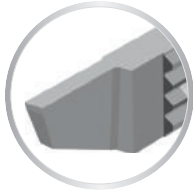

Cut R

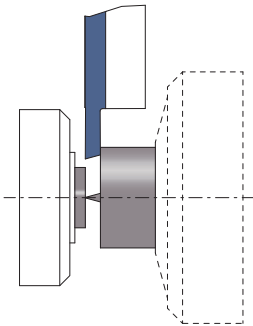
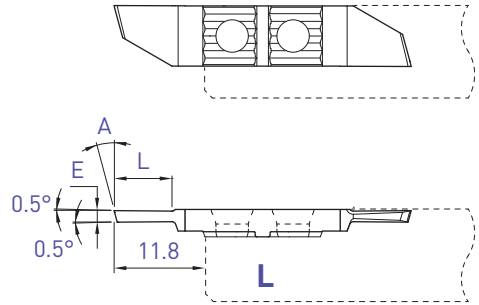

L (R)

Coupe à droite déportée  
Versetzttes Rechtsschneiden  
Right cut off line

E	A	L	Art. N°	Ti/AlN N (µk20)	HTA	HN (µk10)
1.0	15°	5	651R-1.0-15°	■ ■	□ □	
1.2	15°	5	651R-1.2-15°	■ ■	□ □	
1.5	15°	7.5	651R-1.5-15°	■ ■	□ □	
2.0	15°	11	651R-2.0-15°	■ ■	□ □	
2.5	15°	11	651R-2.5-15°	■ ■	□ □	



Tronçonnage  
 Abstechen  
 Parting off

Coupe déportée  
 Versetztes Schneiden  
 Cut off line

651RXF

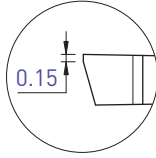
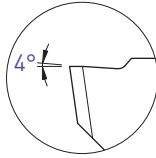
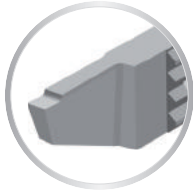

Cut R

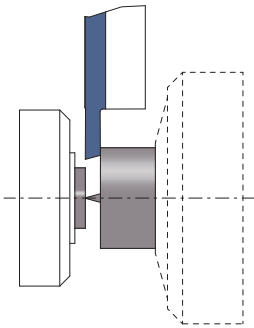
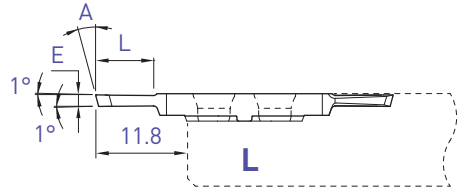
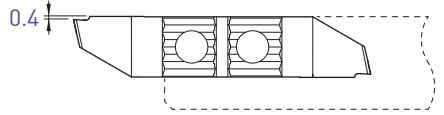

L (R)

Coupe à droite déportée  
 Versetztes Rechtsschneiden  
 Right cut off line

E	A	L	Art. N°	Ti/AlN N (µk20)	HTA	HN (µk10)
1.5	15°	7.5	651RXF-1.5	■ ■	□ □	
2.0	15°	11	651RXF-2.0	■ ■	□ □	

Tronçonnage  
Abstechen  
Parting off

Coupe déportée  
Versetztes Schneiden  
Cut off line

651RX12

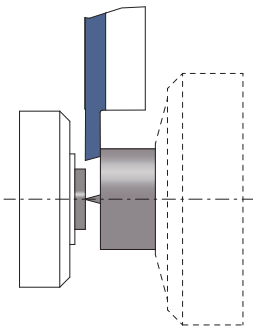
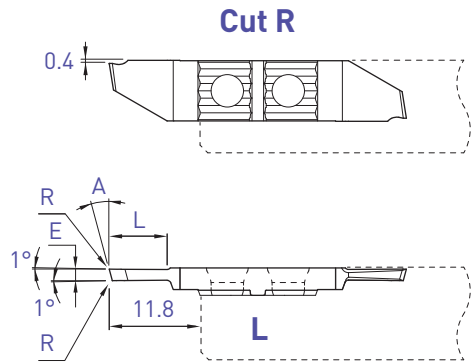
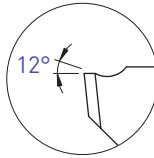
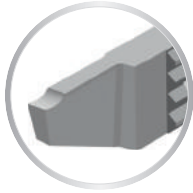

**L (R)**  
Coupe à droite déportée  
Versetztes Rechtsschneiden  
Right cut off line

E	A	L	R	Art. N°	Ti/AIN N (µk20)	HTA	HN (µk10)
1.5	15°	7.5	0.03	651RX12-1.5	■ ■	□ □	
2.0	15°	11	0.03	651RX12-2.0	■ ■	□ □	

Tronçonnage  
 Abstechen  
 Parting off

Coupe déportée  
 Versetztes Schneiden  
 Cut off line

651RU

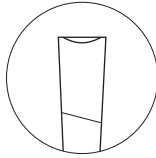

Cut R

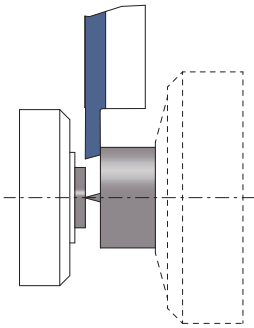
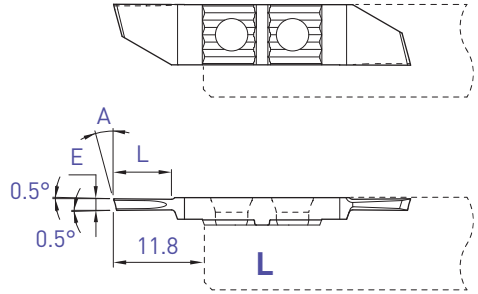

L (R)

Coupe à droite déportée  
 Versetztes Rechtsschneiden  
 Right cut off line

E	A	L	Art. N°	TiAlN N (µk20)
1.5	15°	7.5	651RU-1.5	■ ■
2.0	15°	11	651RU-2.0	■ ■

Tronçonnage  
Abstechen  
Parting off

Coupe déportée  
Versetztes Schneiden  
Cut off line

651RZU

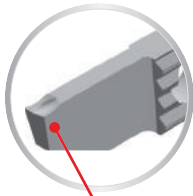
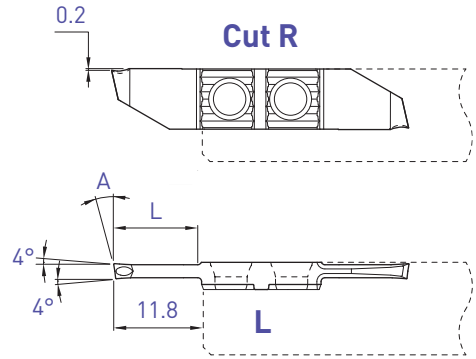
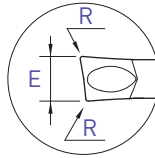
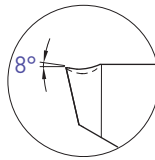

Pour un meilleur contrôle des copeaux  
Für eine bessere Spankontrolle  
For a better chip control

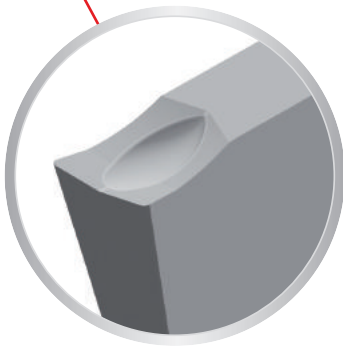

L (R)

Coupe à droite déportée  
Versetztes Rechtsschneiden  
Right cut off line

E	A	L	R	Art. N°	TiAlN N (µm20)
2.0	8°	11	0.10	651RZU8-2.0-8°-R10	■

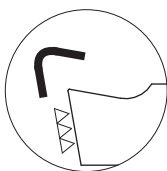

Arête de coupe honée  
Gehonte Schneidkante  
Honed edge

f min: 0.02 mm/U

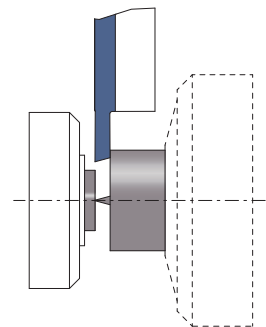

**L**

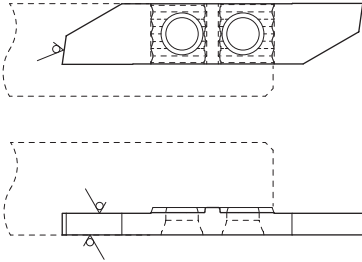

**R**

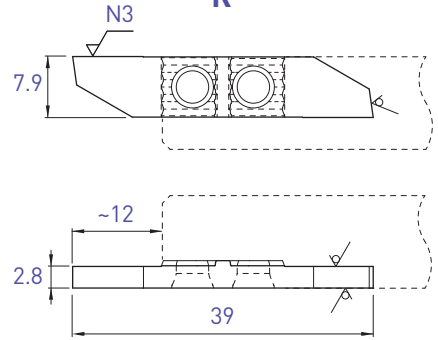





Face de coupe polie  
 Polierte Schneidfläche  
 Polished cutting face

L				R			
Art. N°	TiAlN N (µk20)	HTA	HN (µk10)	Art. N°	TiAlN N (µk20)	HTA	HN (µk10)
651-EP	■ ■	■ ■		661-EP	■ ■	■ ■	

Pièces de rechange et accessoires

Ersatzteile und Zubehöre

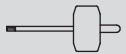
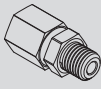
Spare parts and accessories

Pièces de rechange Ersatzteile Spare parts							
Porte-outils Halter Holders						Option Art. N°	Recommandation de serrage Drehmoment Empfehlung Clamping recommendation
630 640			-	-	-		
630-JET 640-JET	<b>V-M4X9-T15</b>		<b>J-M8X1-D6</b>	<b>JB-M8X1</b>	<b>JJ-M3X6-D1.5</b>		
650 660		<b>C-T15</b>	-	-	-	<b>SET-NM-TX15</b>	3 Nm
650-RC	<b>V-M4X6.5-T15</b>		-	-	-		
650-JET 660-JET	<b>V-M4X9-T15</b>		<b>J-M8X1-D6</b>	<b>JB-M8X1</b>	<b>JJ-M3X6-D1.5</b>		

■ = disponible / verfügbar / available

□ = selon disponibilité du stock / jenach Lagerverfügbarkeit / depending on stock availability